

## SKYTABLE

The large format Slab Table  
for areas up to 150m<sup>2</sup> (1600 ft<sup>2</sup>)



Edition 11 | 2014

**PERI GmbH**  
**Schalung Gerüst Engineering**

Rudolf-Diesel-Straße 19  
89264 Weißenhorn  
Deutschland  
Telefon +49 (0)7309.950-0  
Telefax +49 (0)7309.951-0  
info@peri.com  
www.peri.com

**Important Notes**

Without exception, all current safety regulations and guidelines must be observed in those countries where our products are used.

The photos shown in this brochure feature construction sites in progress. For this reason, safety and anchor details in particular cannot always be considered as conclusive or final. These are subject to the risk assessment carried out by the contractor.

The systems or items shown may not be necessarily available in every country.

Safety instructions and load specifications are to be strictly observed at all times. Separate structural calculations are required for any deviations from the standard design data.

The information contained herein is subject to technical changes in the interests of progress. Errors and typographical mistakes reserved.

# Contents

## **SKYTABLE**

- 2 150 m<sup>2</sup> (1600 ft<sup>2</sup>) slab table moved in a few minutes
- 4 The large format table up to  
24.40 m (80 ft) long and 6.10 m (20 ft) wide
- 6 The moving process
- 8 Details that make the PERI SKYTABLE faster
- 10 Components
- 20 PERI International

# PERI SKYTABLE

150 m<sup>2</sup> (1600 ft<sup>2</sup>) slab table moved in a few minutes



**PERI SKYTABLE**, the slab table for areas up to 150 m<sup>2</sup> (1600 ft<sup>2</sup>). Table lengths up to 24.40 m (80 ft) and widths of 6.10 m (20 ft) are possible.

For construction of buildings with open facades, the PERI SKYTABLE is used in one piece for the complete width of the structure.

150 m<sup>2</sup> (1600 ft<sup>2</sup>) of slab formwork can be moved in one crane lift.  
The SKYTABLE - reaching up to 24.40 m (80 ft) x 6.10 m (20 ft) in size - is assembled using only two trusses.



**Project:**  
Highrise building The Bravern,  
Bellevue, Washington, USA.  
**Contractor:**  
SKANSKA, Seattle, Washington, USA.



When the crane raises the lifting carriage, the table is pulled horizontally from the building. The complete moving procedure could be carried out by only three workers and the crane operator.



**Project:**  
Highrise building Minto Midtown Quantum, Toronto, Ontario  
**Contractor:**  
Resform Construction Ltd., Toronto, Canada.

# PERI SKYTABLE

## The large format table up to 24.40 m (80 ft) long and 6.10 m (20 ft) wide

### The key advantages of the PERI SKYTABLE:

- Large area tables with only one crane pick.
- Equipped with MULTIPROP post shores, which provide a large lowering height e.g. for edge beams.
- The table can also be used for larger heights without any changes to the design with the MULTIPROP post shores and frames used in a tower configuration.
- Every MULTIPROP is connected to a quick lowering device so that the props can be released quickly and easily.
- PERI has developed a new method for moving SKYTABLE, which is much safer and less strenuous for site personnel. To accelerate the moving process, the Lifting Mechanism and the Rear Carriage or Single Rollers are used.
- No screwed connections, therefore faster assembly through simple pin connections.

Lifting Traverse STL 120-2  
Lifting Traverse STL 266/207-2

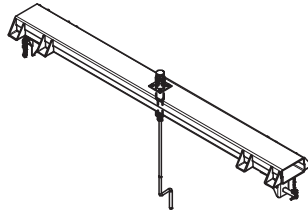

Quick Lowering Device STQ

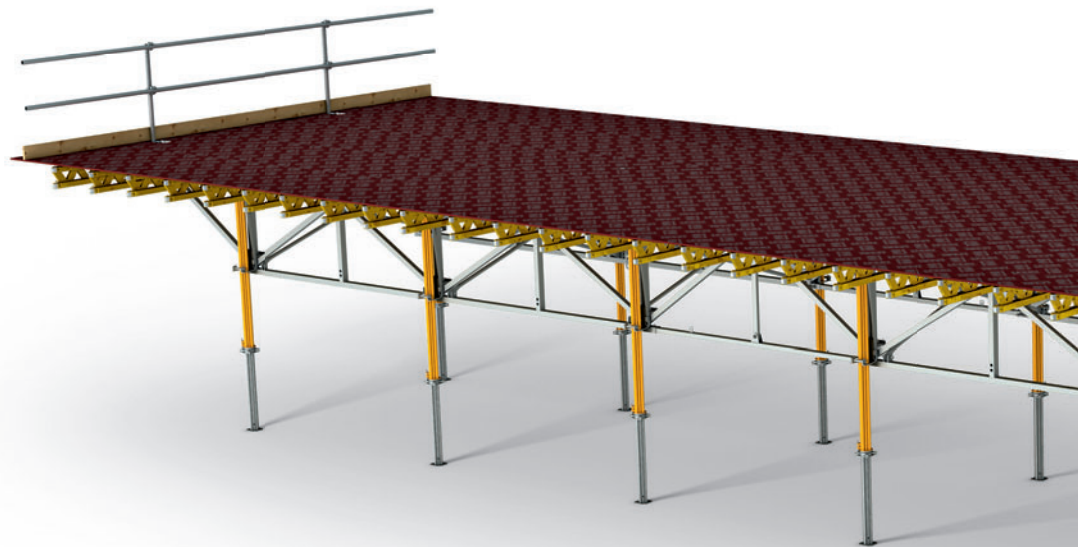
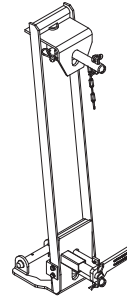

Truss Girder STT 592

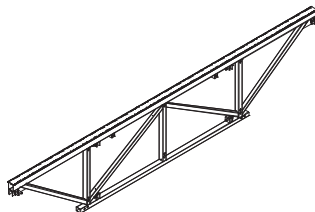

Truss Girder STT 888

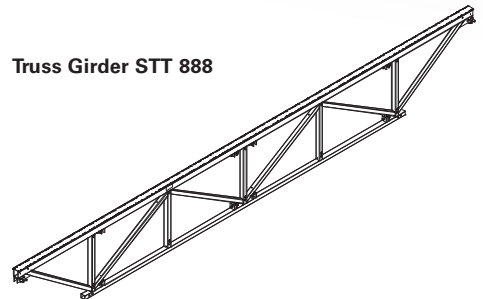

Truss Girder STT 168

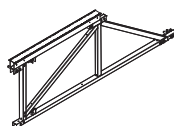

Truss Connector STC

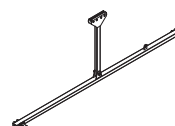

**Guardrail Post STP**



**Crane Eye Adaptor STA**

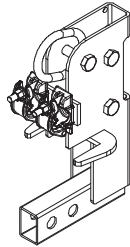

**Tension Plate STMP**

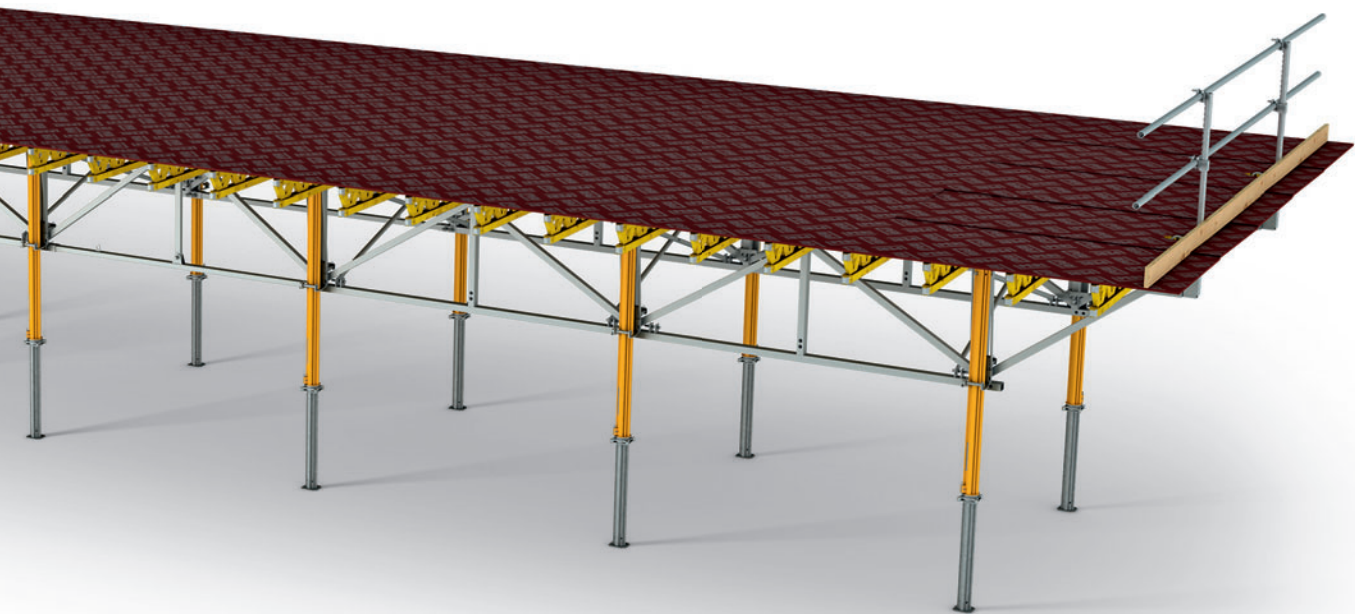
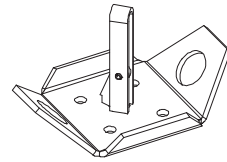

**Diagonal Brace STD 266 x 87**  
**Diagonal Brace STD 207 x 87**  
**Diagonal Brace STD 120 x 87**

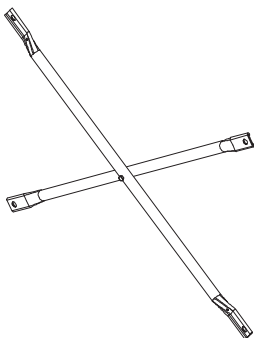

**Spreader Tube STST 120**  
**Spreader Tube STST 207**  
**Spreader Tube STST 266**

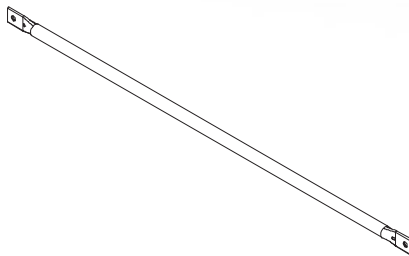

**Connector STG 24**



# PERI SKYTABLE

## The moving process

### The moving process in detail

1. Use the Quick Lowering Device to release the prop load. Mount Rear Carriage STR or Single Roller STE to the second last prop and secure with tension belts. Move inner tubes of MULTIPROP inwards by about 50 cm (20 in) except for the second pair of props from the edge of the building.

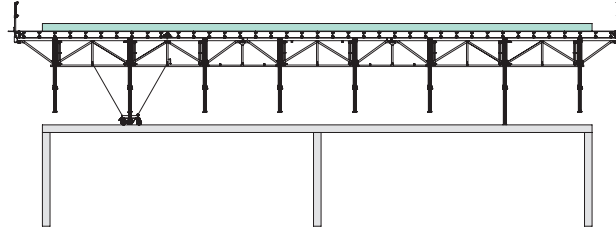

2. Lower table by approx. 40 cm (16 in). Clamp Chain Guidance Shoe STMS to the slab edge, position the Lifting Mechanism STM on the slab edge. Pull the Lifting Head STH and one sling chain under the slab to the rear.

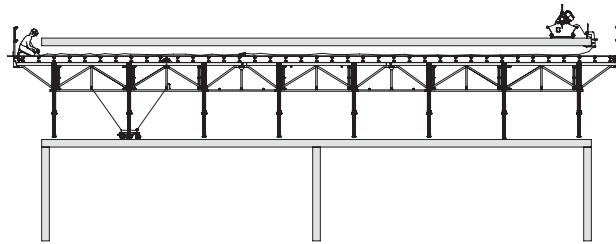

3. Attach the Lifting Shoe STH to the rear area. Fold down the rear guardrail. Attach the two-sling chain at the front on the cantilevered table end.

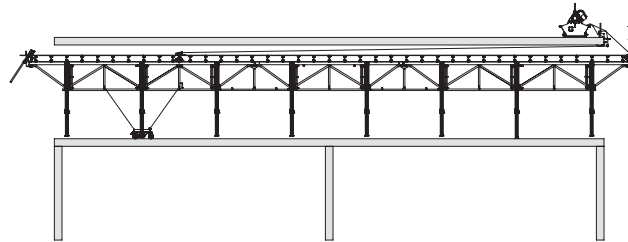

4. The crane pulls the Lifting Mechanism STM upwards and, because of this, the table is pulled horizontally out of the building by means of the Chain Guidance Plate, which is attached to the slab edge. In order for the table to remain in a horizontal position, the chain is transported in the Lifting Mechanism accordingly.

#### Advantage:

The rear guardrail can be folded down and remains fixed to the SKYTABLE! Site personnel work from a safe position in the building during the moving process.

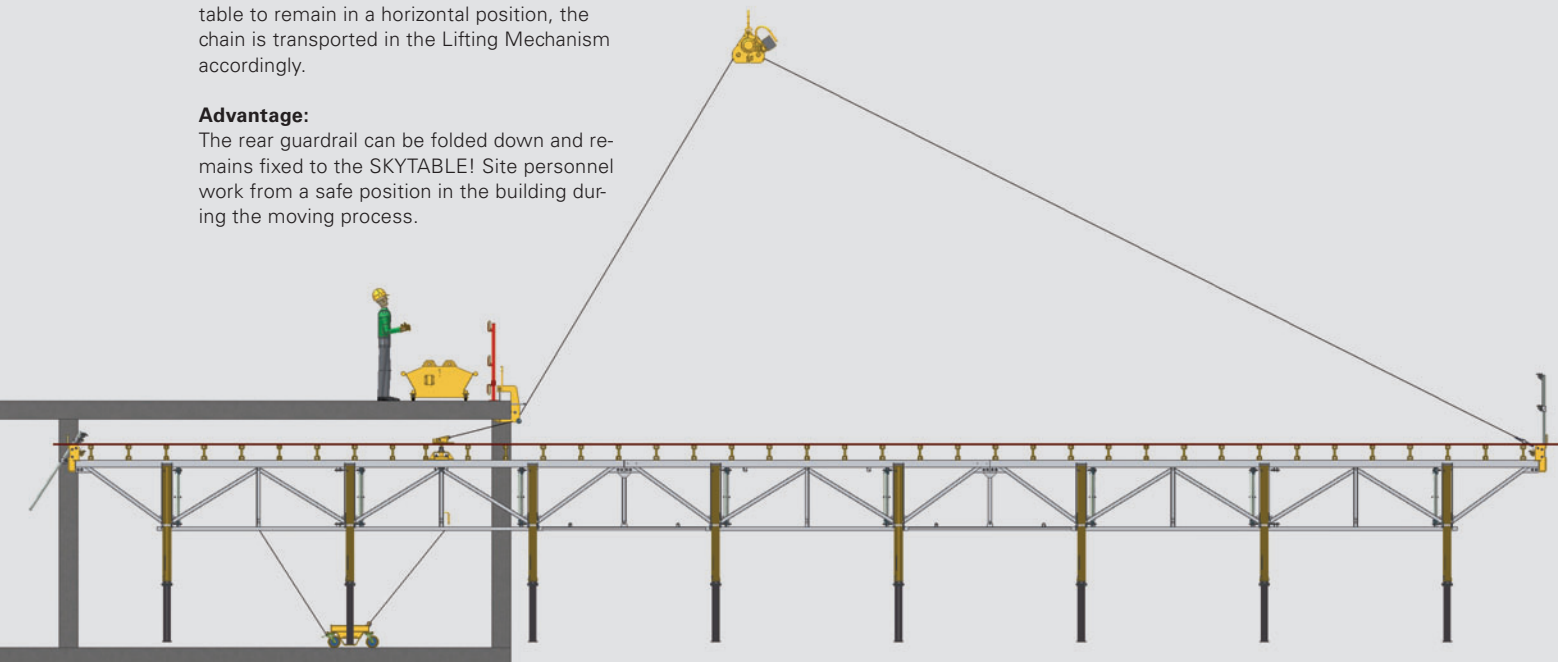



**The PERI SKYTABLE moving procedure provides a high level of safety.**

Site crews are always working from a safe and secure position on the slab edge. Workers are not required to stand on the slab table at any time during the moving process.



Using STT trusses that are simply linked together, table lengths of up to 24.40 m (80 ft) are created which are moved in only one crane lift.

The Lifting Mechanism STM is operated using a remote control and ensures that the slab table is kept in a horizontal position when being moved.



**Chain Guidance Shoe STMS**

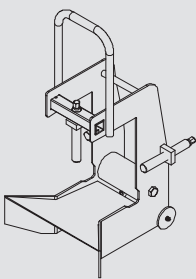

**Chain Guidance Shoe STMS adjustable**

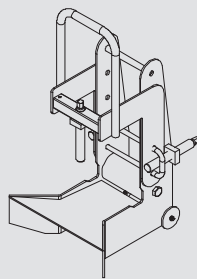

**Lifting Head STH**

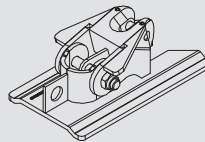

**Lifting Traverse STL 120-2  
Lifting Traverse STL 266/207-2**

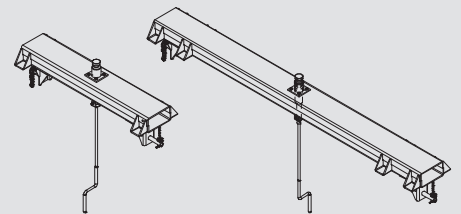

**Lifting Mechanism STM**

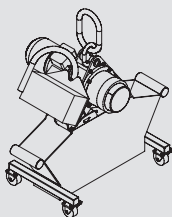

**Single Roller STE**

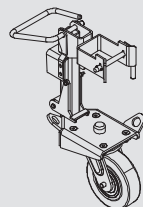

**Hydraulic Lowering Device STN-2**

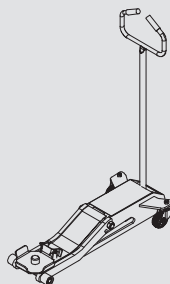

**Rear Carriage STR 296/237  
Rear Carriage STR 150**

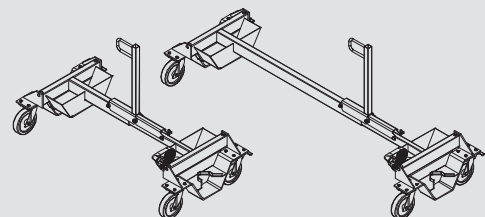

# PERI SKYTABLE

## Details that make the PERI SKYTABLE faster

### Moving with single roller.

Alternatively, moving SKYTABLE with the Rear Carriage can also be done with the Single Roller. Lowering is achieved with the Hydraulic Lowering Device.

Single Roller STE



### Safe handling of the SKYTABLE table lifting equipment.

From a safe and secure area through a plywood opening behind the Lifting Traverse STL, the rear lifting point on the Lifting Traverse is mounted with the Lifting Head STH.

Lifting Traverse STL 120-2  
Lifting Traverse STL 266/207-2



Hydraulic Lowering Device STN-2



### Easy prop load release.

MULTIPROP post shores are fixed in the Lowering Device. This allows simple release of high prop loads. Unlocking the Quick Lowering Device is carried out with a simple movement of the red handle.

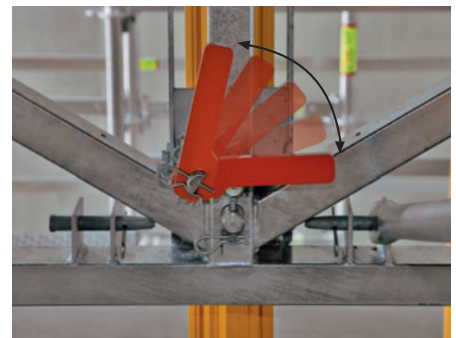

With a simple movement of the red handle, the Quick Lowering Device is unlocked and the PERI SKYTABLE is lowered by 20 mm.

**Construction of SKYTABLE with 3 shear frames.**

For moving the tables, the Lifting Adaptor and the Horizontal Brace are used.

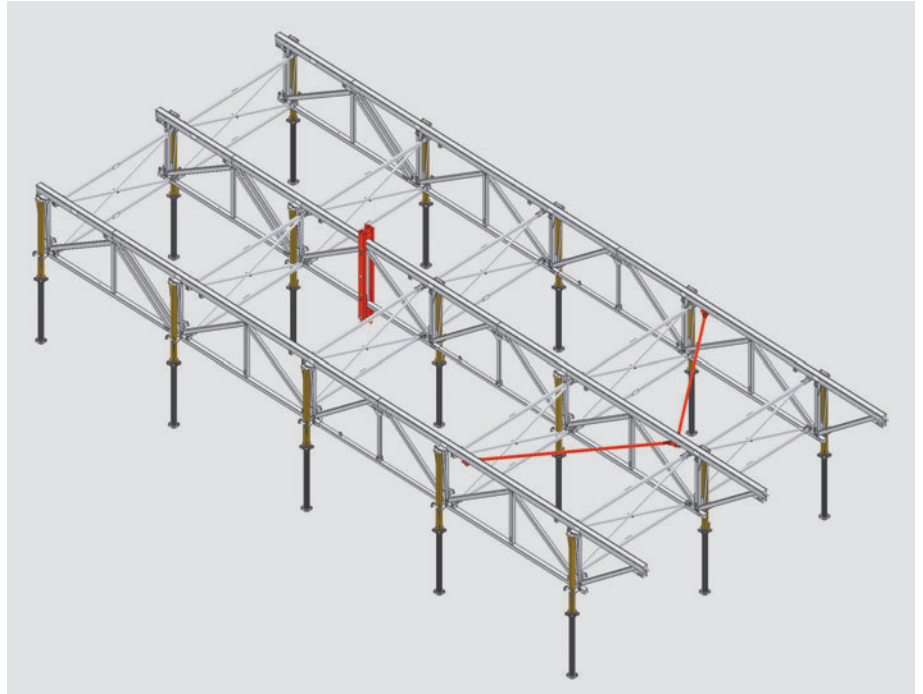
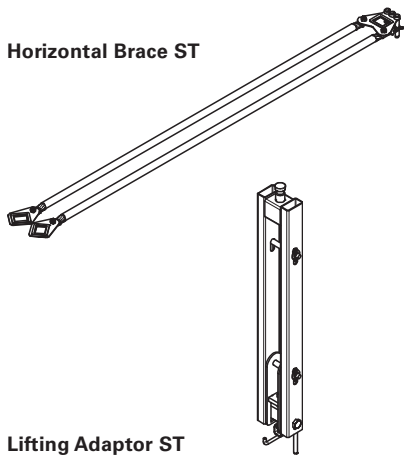

**Fast assembly of SKYTABLE.**

The truss construction is assembled using pins and cotter pins.

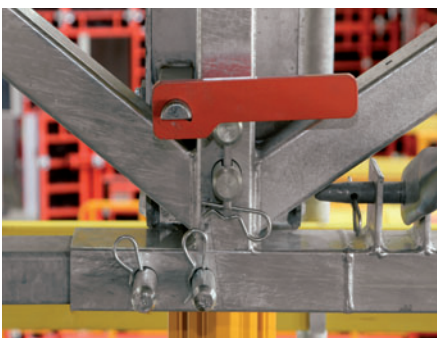

**Lowerable guardrail.**

During the moving process, the guardrail on the rear end of the table is slid downwards. The table can be moved under the concreted slab without having to dismantle the guardrail.

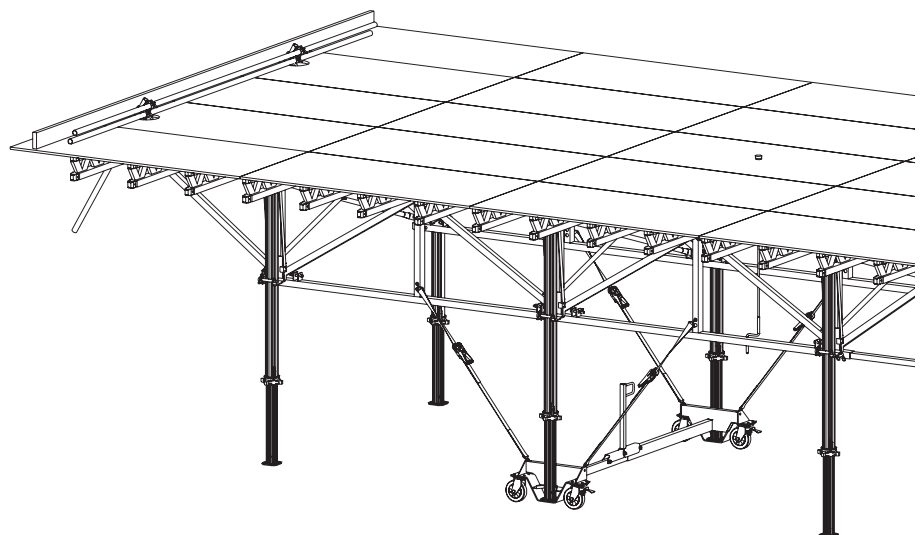

# SKYTABLE Slab Table



Item no.	Weight kg
107592	232,000

**Truss Girder STT 888, galv.**

**Complete with**

- 4 pc. 107579 Pin Ø 25 x 154, galv.
- 8 pc. 105400 Pin Ø 20 x 140, galv.
- 12 pc. 018060 Cotter Pin 4/1, galv.

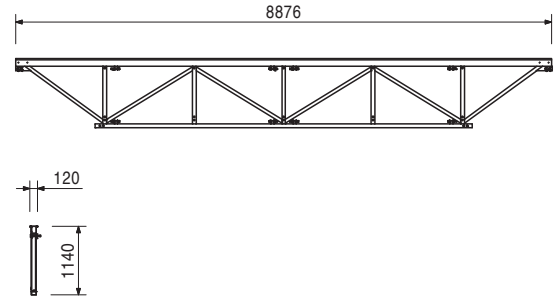
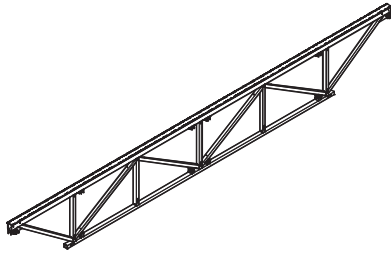

107599	147,000
--------	---------

**Truss Girder STT 592, galv.**

**Complete with**

- 4 pc. 107579 Pin Ø 25 x 154, galv.
- 4 pc. 105400 Pin Ø 20 x 140, galv.
- 8 pc. 018060 Cotter Pin 4/1, galv.

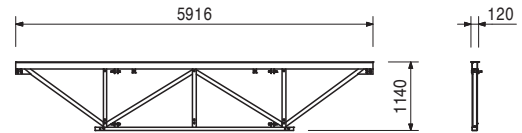
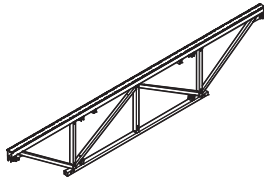

107800	83,000
--------	--------

**Truss Girder STT 168, galv.**

**Complete with**

- 4 pc. 107579 Pin Ø 25 x 154, galv.
- 2 pc. 105400 Pin Ø 20 x 140, galv.
- 6 pc. 018060 Cotter Pin 4/1, galv.

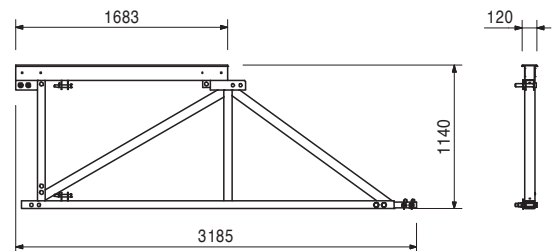
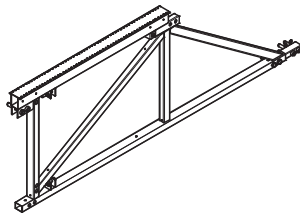

107667	31,500
--------	--------

**Truss Connector STC, galv.**

For connecting 2 Truss Girder STT.

**Complete with**

- 4 pc. 107579 Pin Ø 25 x 154, galv.
- 4 pc. 018060 Cotter Pin 4/1, galv.

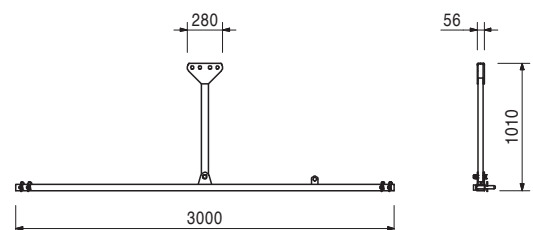
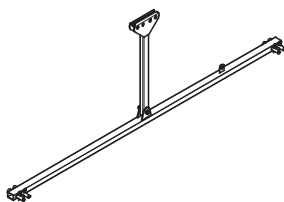

# SKYTABLE Slab Table

Item no.	Weight kg
107561	8,000
107564	11,900
107567	14,700

**Diagonal Brace STD, galv.**  
**Diagonal Brace STD 120 x 87**  
**Diagonal Brace STD 207 x 87**  
**Diagonal Brace STD 266 x 87**

For diagonal bracing of SKYTABLE.

L	X	Y
1545	1204	870
2307	2072	870
2862	2664	870

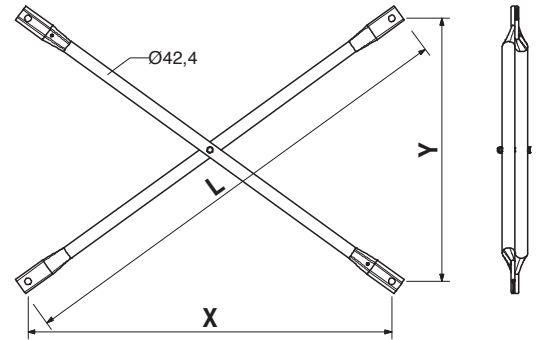
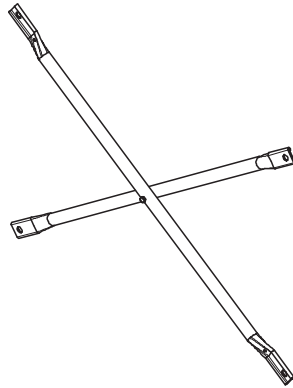

108106	5,460
108105	9,920
107915	14,000

**Spreader Tube STST, galv.**  
**Spreader Tube STST 120, galv.**  
**Spreader Tube STST 207, galv.**  
**Spreader Tube STST 266, galv.**

For horizontal bracing of SKYTABLE in diagonal frame construction.

L	X
1264	1204
2132	2072
2724	2664

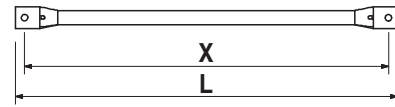
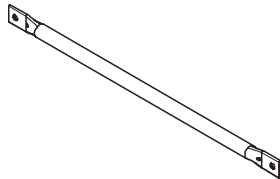

107641	20,700
--------	--------

**Quick Lowering Device STQ, galv.**

For releasing loads by 20 mm.

Connection between Truss Girder and MULTIPROP.

**Complete with**

1 pc. 715357 Pin Ø 16 x 150, galv.

5 pc. 018060 Cotter Pin 4/1, galv.

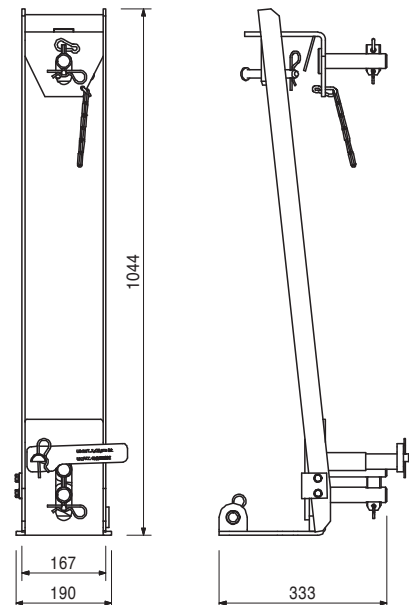

Item no.	Weight kg
108133	0,833

### Connector STG 24, galv.

For connecting the GT 24 Girders to the Truss Girder STT near the props.

### Note

2 piece per fixing point.

### Technical Data

The Connector STG 24 must always be secured with nails!

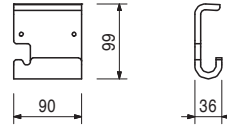
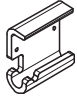

107690	12,100
--------	--------

### Crane Eye Adaptor STA

For connecting Guardrail Post STP to the Truss Girder STT. As bracket for moving.

### Technical Data

Permissible load-bearing point capacity is balanced according to the Lifting Mechanism STM and permissible SKYTABLE data.

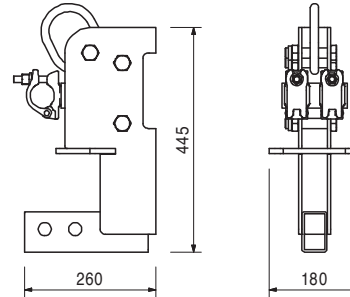
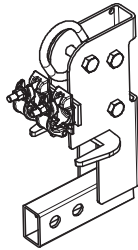

Accessories

107737	8,810
--------	-------

### Guardrail Post STP, galv.

107737	8,810
--------	-------

### Guardrail Post STP, galv.

For use with Crane Eye Adaptor STA.

### Technical Data

Guardrail height 1.10 m.

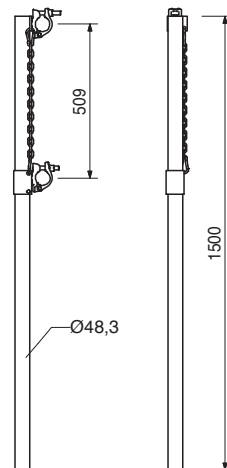

# SKYTABLE Slab Table



Item no.	Weight kg
108188	3,440

## Tension Plate STMP

In conjunction with the Tension Belt STLB for transferring horizontal loads in the longitudinal direction of the table.

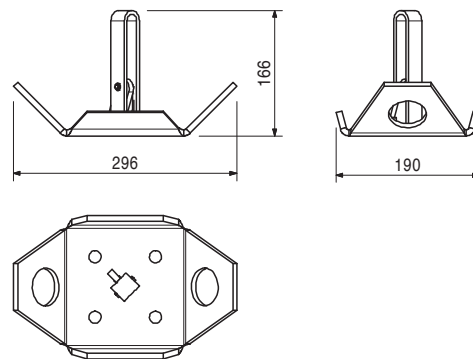
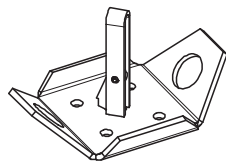

107895	1,430
--------	-------

Accessories

## Tension Belt STLB

111777	57,700
--------	--------

## Lifting Adaptor ST

For moving PERI SKYTABLE with 3 shear frames.

### Note

Follow Instructions for Assembly and Use!

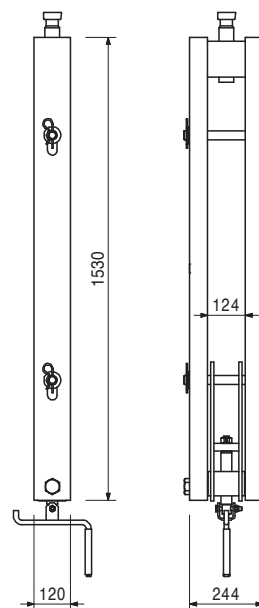

111773	31,000
--------	--------

## Horizontal Brace ST

For horizontal bracing of PERI SKYTABLE in the upper diagonal level at tables with 3 shear frames.

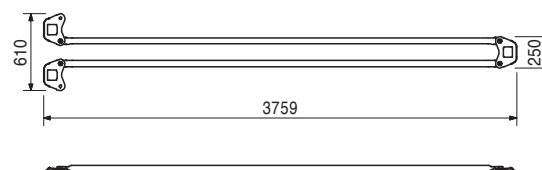
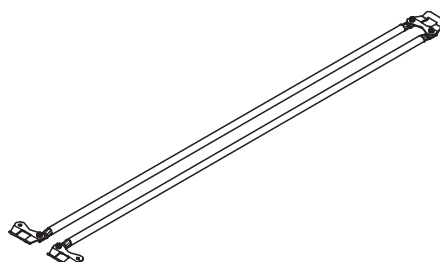

Item no.	Weight kg
110832	12,000

## Diagonal Cross Connection STO

For the use of re-positioned MULTIPROP post shores on the Truss Girder STT.

## Complete with

2 pc. 105400 Pin Ø 20 x 140, galv.  
2 pc. 018060 Cotter Pin 4/1, galv.

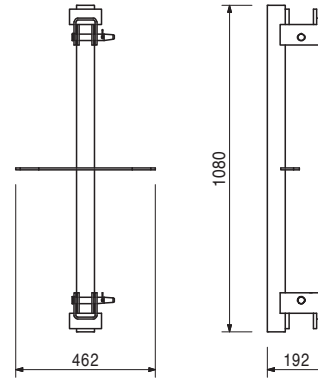
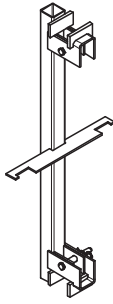

114965	13,600
--------	--------

## Telescopic Extension ST

For longitudinal compensations of 50 - 90 cm with additional support. Inserted into the top chord of the Truss Girder STT.

## Complete with

1 pc. 107579 Pin Ø 25 x 154, galv.  
1 pc. 018060 Cotter Pin 4/1, galv.

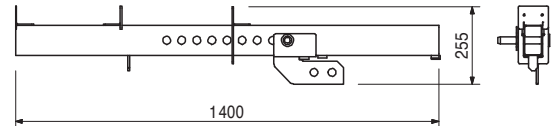
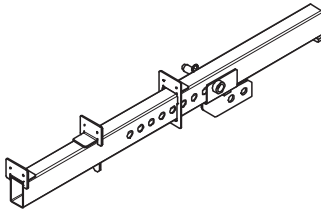

112175	142,000
--------	---------

## Beam Truss ST

For forming beams. Mounted on Truss Girder STT by means of pins and cotter pins.

## Complete with

5 pc. 107579 Bolt Ø 25 x 154, galv.  
6 pc. 105400 Bolt Ø 20 x 140, galv.  
11 pc. 018060 Cotter Pin 4/1, galv.  
4 pc. 029560 Bolt ISO 4014 M24 x 120-10.9, galv.  
4 pc. 105032 Nut ISO 7042 M24-8, galv.

## Note

For beams up to maximum 60 cm wide and 75 cm high.

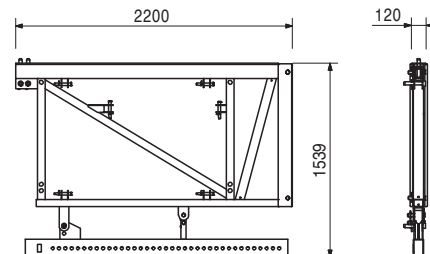
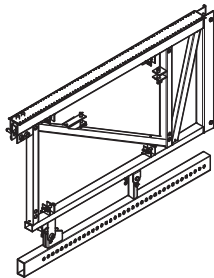



# SKYTABLE Slab Table



Item no.	Weight kg
111300	502,000
113030	502,000
114103	502,000

**Lifting Mechanism STM**  
**Lifting Mechanism STM 600 V / 60 HZ**  
**Lifting Mechanism STM 480 V / 60 HZ**  
**Lifting Mechanism STM 400 V / 50 HZ**

For moving PERI SKYTABLE. With chain hoist and chains. Included in delivery is a accessories box with remote control, charger and documentation.

**Complete with**  
 1 pc. 107709 Lifting Head STH

**Technical Data**  
 Permissible load-bearing capacity: 6.0 t  
 Max. table length: 24.40 m  
 Power: 0.9 – 3.5 KW  
 Chain speed: 1.6 m and 6.3 m/min.

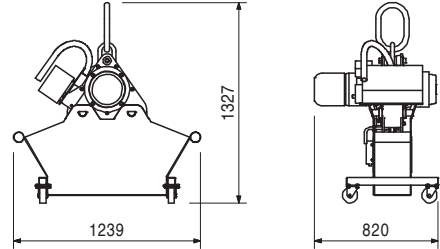
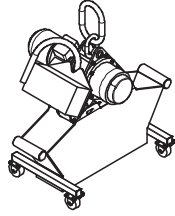

107736	26,900
--------	--------

## Chain Guidance Shoe STMS

For fixing to the slab edge as chain guidance plate when moving.  
 Slab thickness 195 mm to 335 mm.

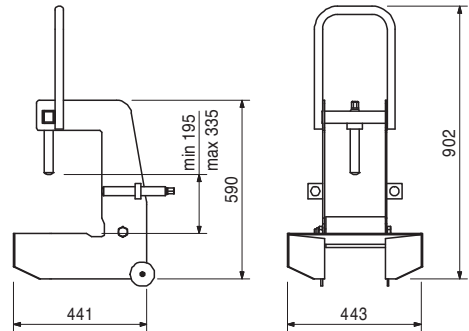
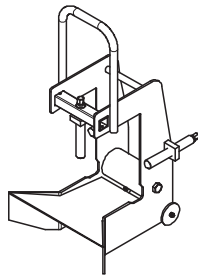

110153	32,600
--------	--------

## Chain Guidance Shoe STMS adjustable

For fixing to the slab edge as chain guidance plate when moving.  
 Slab thickness 195 mm to 635 mm.

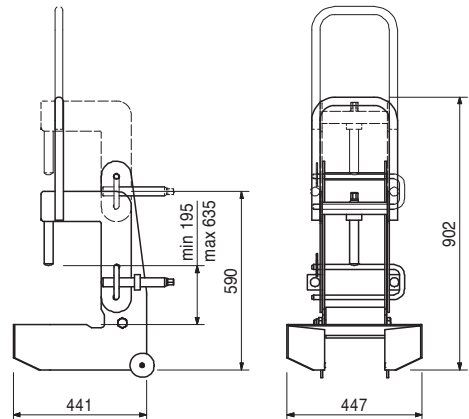
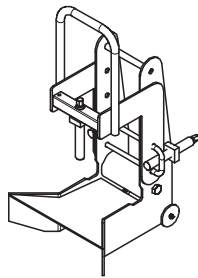

Item no.	Weight kg
109388	95,400

## Spreader Beam STL 120-2

For moving PERI SKYTABLE with 2 shear frames.

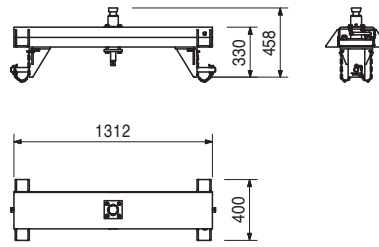
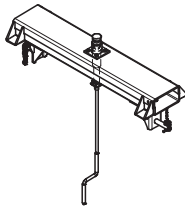

109373	167,000
--------	---------

## Spreader Beam STL 266/207-2

For moving PERI SKYTABLE with 2 shear frames.

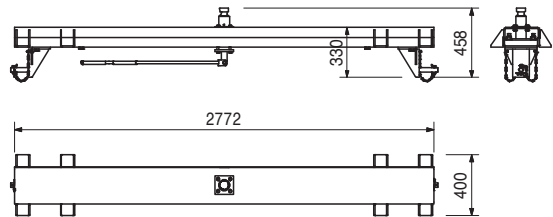
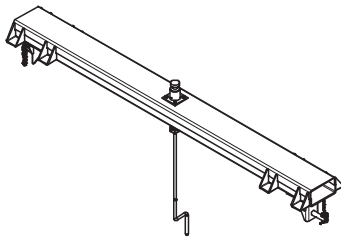

114740	16,400
--------	--------

## Lifting Traverse Crane Eye slidable ST

For moving eccentrically-positioned SKYTABLE. Mounted to the Lifting Traverse STL.

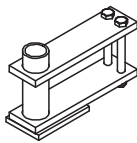

### Complete with

2 pc. 706462 Bolt ISO 4014 M20 x 200-8.8, galv.  
2 pc. 781053 Nut ISO 7042 M20-8, galv.

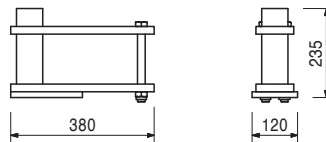

107895	1,430
--------	-------

## Tension Belt STLB

For fixing of Single Roller STE at SKYTABLE and for anchoring of slab tables.

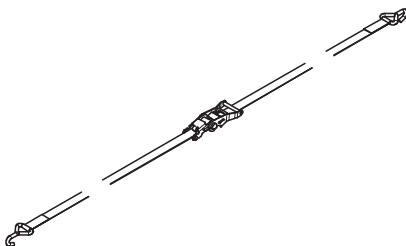

### Note

2 pieces required per Single Roller STE. (SKYTABLE)

### Technical Data

Permissible tension force = 10 kN

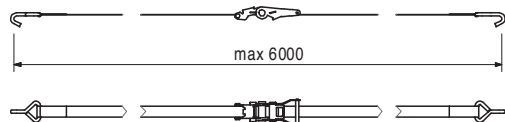

# SKYTABLE Slab Table



Item no.	Weight kg
107709	10,700

## Lifting Head STH

For connecting the one chain end to the SKYTABLE at the rear area.

## Technical Data

Permissible load-bearing point capacity is balanced according to the Lifting Mechanism STM and permissible SKYTABLE data.

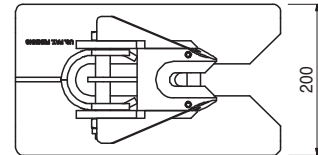
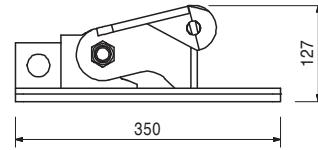
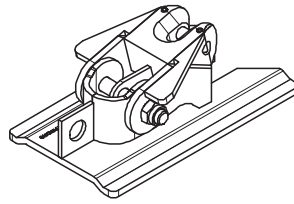

107602	111,000
--------	---------

## Rear Carriage STR 150

For travelling the PERI SKYTABLE when moving.

## Complete with

4 pc. 109324 Tension Belt RS 4000, 6 m – 35 mm

## Technical Data

Permissible tension force = 10 kN

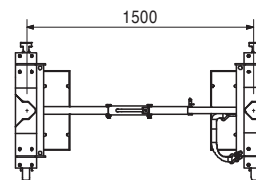
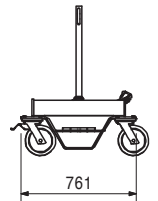
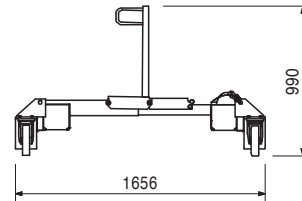
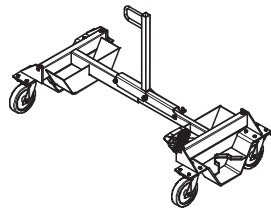

107569	124,000
--------	---------

## Rear Carriage STR 296/237

For travelling the PERI SKYTABLE when moving.

## Complete with

4 pc. 109324 Tension Belt RS 4000, 6 m – 35 mm

## Technical Data

Permissible tension force = 10 kN

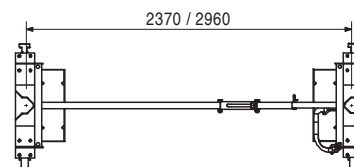
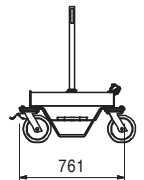
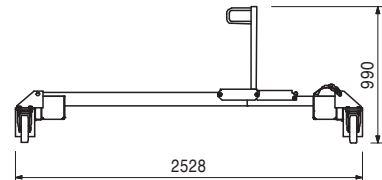
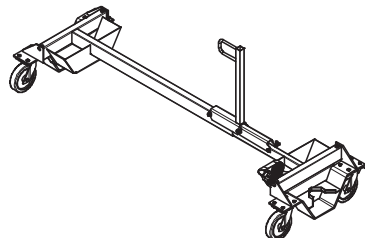

# SKYTABLE Slab Table



Item no.	Weight kg
115476	49,900

## Triple Roller ST

For shifting the PERI SKYTABLE during the moving process.

## Complete with

2 pc. 115215 Anchor Chain ST 3.0 kN, l = 2.50 m

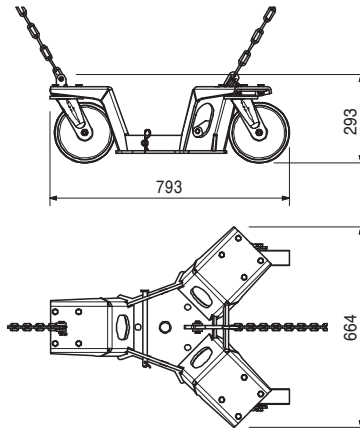
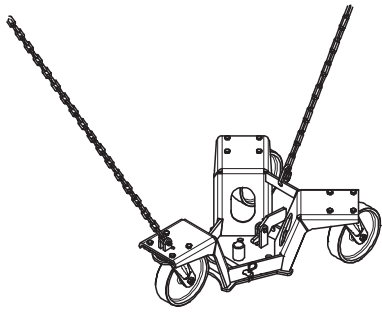

111778	22,200
--------	--------

## Single Roller STE

For travelling the PERI SKYTABLE when moving.

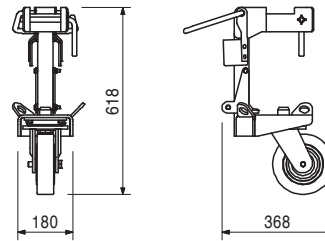
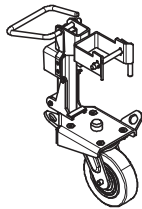

107895	1,430
--------	-------

Accessories

## Tension Belt STLB

111698	45,600
115021	68,800

## Hydraulic Lowering Device STN Hydraulic Lowering Device STN 2.0 t Hydraulic Lowering Device STN 6.0 t

For lowering the PERI SKYTABLE when moving.

## Technical Data

Permissible load-bearing capacity 2.0 t, resp. 6.0 t.

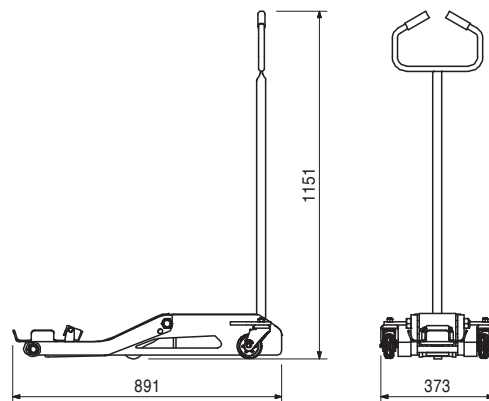
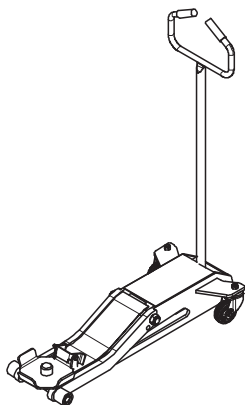

Item no.	Weight kg
115804	8,780

### Chain Extension STV 120

For moving SKYTABLE tables with 3 truss girder sections in connection with the Lifting Carriage STM.

### Technical Data

Chain length approx. 1.20 m.

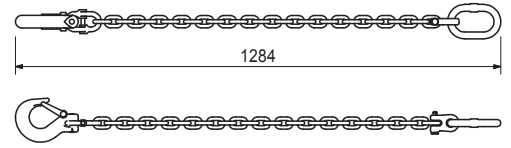
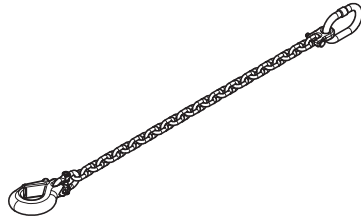

# PERI International

**01 Germany**  
**PERI GmbH**  
 Rudolf-Diesel-Strasse 19  
 89264 Weissenhorn  
 info@peri.com  
 www.peri.com



**02 France**  
 PERI S.A.S.  
 77109 Meaux Cedex  
 peri.sas@peri.fr  
 www.peri.fr

**03 Switzerland**  
 PERI AG  
 8472 Ohringen  
 info@peri.ch  
 www.peri.ch

**04 Spain**  
 PERI S.A.U.  
 28110 Algete - Madrid  
 info@peri.es  
 www.peri.es

**05 Belgium/Luxembourg**  
 N.V. PERI S.A.  
 1840 Londerzeel  
 info@peri.be  
 www.peri.be

**06 Netherlands**  
 PERI Holding B.V.  
 5480 AH-Schijndel  
 info@peri.nl  
 www.peri.nl

**07 USA**  
 PERI Formwork Systems, Inc.  
 Elkridge, MD 21075  
 info@peri-usa.com  
 www.peri-usa.com

**08 Indonesia**  
 PT Beton Perkasa Wijaksana  
 Jakarta 10210  
 bpw@betonperkasa.com  
 www.peri.com

**09 Italy**  
 PERI S.p.A.  
 20060 Basiano  
 info@peri.it  
 www.peri.it

**10 Japan**  
 PERI Japan K.K.  
 Tokyo 103-0015  
 info@perijapan.jp  
 www.perijapan.jp

**11 United Kingdom/Ireland**  
 PERI Ltd.  
 Rugby, CV23 0AN  
 info@peri.ltd.uk  
 www.peri.ltd.uk

**12 Turkey**  
 PERI Kalip ve Iskeleleri Sanayi  
 ve Ticaret Ltd.  
 Esenyurt / Istanbul 34510  
 info@peri.com.tr  
 www.peri.com.tr

**13 Hungary**  
 PERI Kft.  
 1181 Budapest  
 info@peri.hu  
 www.peri.hu

**14 Malaysia**  
 PERI Formwork Malaysia Sdn. Bhd.  
 43300 Seri Kembangan,  
 Selangor Darul Ehsan  
 info@perimalaysia.com  
 www.perimalaysia.com

**15 Singapore**  
 PERI Asia Pte Ltd  
 Singapore 387355  
 pha@periasia.com  
 www.periasia.com

**16 Austria**  
 PERI Ges.mbh  
 3134 Nußdorf ob der Traisen  
 office@peri.at  
 www.peri.at

**17 Czech Republic**  
 PERI spol. S r.o.  
 252 42 Jesenice u Prahy  
 info@peri.cz  
 www.peri.cz

**18 Denmark**  
 PERI Danmark A/S  
 2670 Greve  
 peri@peri.dk  
 www.peri.dk

**19 Finland**  
 PERI Suomi Ltd. Oy  
 05460 Hyvinkää  
 info@perisuomi.fi  
 www.perisuomi.fi

**20 Norway**  
 PERI Norge AS  
 3036 Drammen  
 info@peri.no  
 www.peri.no

**21 Poland**  
 PERI Polska Sp. z o.o.  
 05-860 Plochocin  
 info@peri.com.pl  
 www.peri.com.pl

**22 Sweden**  
 PERIform Sverige AB  
 30262 Halmstad  
 peri@periform.se  
 www.periform.se

**23 Korea**  
 PERI (Korea) Ltd.  
 Seoul 135-936  
 info@perikorea.com  
 www.perikorea.com

**24 Portugal**  
 Pericofragens Lda.  
 2790-326 Queijas  
 info@peri.pt  
 www.peri.pt

**25 Argentina**  
 PERI S.A.  
 B1625GPA Escobar – Bs. As.  
 info@peri.com.ar  
 www.peri.com.ar

**26 Brazil**  
 PERI Formas e  
 Escoramentos Ltda.  
 Vargem Grande Paulista – SP  
 info@peribrasil.com.br  
 www.peribrasil.com.br

**27 Chile**  
 PERI Chile Ltda.  
 Colina, Santiago de Chile  
 perichile@peri.cl  
 www.peri.cl

**28 Romania**  
 PERI România SRL  
 077015 Balotești  
 info@peri.ro  
 www.peri.ro

**29 Slovenia**  
 PERI Agency  
 2000 Maribor  
 peri.slo@triera.net  
 www.peri.com

**30 Slovakia**  
 PERI spol. s. r.o.  
 903 01 Senec  
 info@peri.sk  
 www.peri.sk

**31 Australia**  
 PERI Australia Pty. Ltd.  
 Glendenning NSW 2761  
 info@periaus.com.au  
 www.periaus.com.au

**32 Estonia**  
 PERI AS  
 76406 Saku vald  
 Harjumaa  
 peri@peri.ee  
 www.peri.ee

**33 Greece**  
 PERI Hellas Solely Owned Ltd.  
 194 00 Koropi  
 info@perihellas.gr  
 www.perihellas.gr

**34 Latvia**  
 PERI SIA  
 2118 Salaspils novads, Rigas rajons  
 info@peri-latvija.lv  
 www.peri-latvija.lv

**35 United Arab Emirates**  
 PERI (L.L.C.)  
 Bolton, ON – L7E 1K1  
 perillc@perime.com  
 www.perime.com

**36 Canada**  
 PERI Formwork Systems, Inc.  
 Bolton, ON – L7E 1K1  
 info@peri.ca  
 www.peri.ca



**37 Lebanon**  
PERI Lebanon Sarl  
90416 – Jdeideh  
lebanon@peri.de

**38 Lithuania**  
PERI UAB  
02300 Vilnius  
info@peri.lt  
www.peri.lt

**39 Morocco**  
PERI S.A.U.  
Tanger  
info@peri.ma  
www.peri.ma

**40 Israel**  
PERI Formwork  
Engineering Ltd.  
Rosh Ha'ayin, 48104  
info@peri.co.il  
www.peri.co.il

**41 Bulgaria**  
PERI Bulgaria EOOD  
1839 Sofia  
peri.bulgaria@peri.bg  
www.peri.bg

**42 Iceland**  
Armar ehf.  
220 Hafnarfjörður  
armar@armar.is  
www.armar.is

**43 Kazakhstan**  
TOO PERI Kazakhstan  
050000 Almaty  
peri@peri.kz  
www.peri.kz

**44 Russian Federation**  
OOO PERI  
142407, Noginsk District  
moscow@peri.ru  
www.peri.ru

**45 South Africa**  
PERI (Pty) Ltd  
7600 Stellenbosch  
info@peri.co.za  
www.peri.co.za

**46 Ukraine**  
PERI Ukraina  
07400 Brovary  
peri@peri.ua  
www.peri.ua

**47 Egypt**  
PERI Branch Office  
11341 Nasr City /Cairo  
info@peri.com.eg  
www.peri.com.eg

**48 Serbia**  
PERI – Oplate d.o.o.  
22310 Šimanovci  
office@peri.rs  
www.peri.rs

**49 Mexico**  
PERI Cimbras y Andamios,  
S.A. de C.V.  
Estado de México, Huehuetoca  
info@peri.com.mx  
www.peri.com.mx

**50 Azerbaijan**  
PERI Representative Office  
Baku  
peribaku@peri.com.tr  
www.peri.com.tr

**51 Turkmenistan**  
PERI Kalıp ve İskeleleri  
Aşgabat  
ahmet.kadioglu@peri.com.tr  
www.peri.com.tr

**52 Belorussia**  
IOOO PERI Belarus  
220100 Minsk  
info@peri.by  
www.peri.by

**53 Croatia**  
PERI oplate i skele d.o.o.  
10 250 Lučko-Zagreb  
info@peri.com.hr  
www.peri.com.hr

**54 India**  
PERI (India) Pvt Ltd  
Mumbai – 400064  
info@peri.in  
www.peri.in

**55 Jordan**  
PERI GmbH - Jordan  
11947 Amman  
jordan@peri.com  
www.peri.com

**56 Kuwait**  
PERI Kuwait W.L.L.  
13011 Kuwait  
info@peri.com.kw  
www.peri.com.kw

**57 Saudi Arabia**  
PERI Saudi Arabia Ltd.  
21463 Jeddah  
info@peri.com.sa  
www.peri.com.sa

**58 Qatar**  
PERI Qatar LLC  
P.O.Box: 31295 - Doha  
info@periqatar.com  
www.peri.qa

**59 Algeria**  
PERI PERI  
Kouba 16092, Alger  
info@peri.com  
www.peri.com

**60 Albania**  
PERI Representative Office  
Tirane  
info@peri.com.tr  
www.peri.com.tr

**61 Peru**  
PERI Peruana S.A.C.  
Villa El Salvador, Lima  
contacto@peri.com.pe  
www.peri.com.pe

**62 Panama**  
PERI Panama Inc.  
0832-00155 Panama City  
info@peri.com.pa  
www.peri.com.pa

**63 Angola**  
Pericofragens, Lda.  
Luanda  
renato.portugal@peri.pt  
www.peri.pt

**64 Nigeria**  
PERI Nigeria Ltd.  
Lagos  
info@peri.ng  
www.peri.ng

**65 Oman**  
PERI (L.L.C.)  
Muscat  
perimct@perime.com  
www.perime.com

**66 Colombia**  
PERI S.A.S. Colombia  
Briceño, Cundinamarca  
peri.colombia@peri.com.co  
www.peri.com.co

**67 Philippines**  
PERI-Asia Philippines, INC.  
Makati City  
info@peri.com.ph  
www.peri.com.ph

# The optimal System for every Project and every Requirement



Wall Formwork



Column Formwork



Slab Formwork



Climbing Systems



Tunnel Formwork



Bridge Formwork



Shoring Systems



Construction Scaffold



Facade Scaffold



Industrial Scaffold



Access



Protection Scaffold



System-Independent Accessories



Services



**PERI GmbH**  
**Formwork Scaffolding Engineering**  
 Rudolf-Diesel-Strasse 19  
 89264 Weissenhorn  
 Germany  
 Tel. +49 (0)7309.950-0  
 Fax +49 (0)7309.951-0  
 info@peri.com  
 www.peri.com