

## LICO

The lightweight column formwork  
for forming by hand



# PERI LICO

## Crane-independent, flexible, inexpensive

**LICO, the lightweight column formwork for cost-effective forming also without a crane.**

The low individual weights of the elements allow assembly and dismantling by hand. This means that the formwork crew is still in a position to effectively use crane non-availability in a productive way.

Practical details simplify the use and lower shuttering times.

The high permissible fresh concrete pressure of  $80 \text{ kN/m}^2$  ensures fast concreting cycles and thus contributes to a very economical utilisation of the equipment.

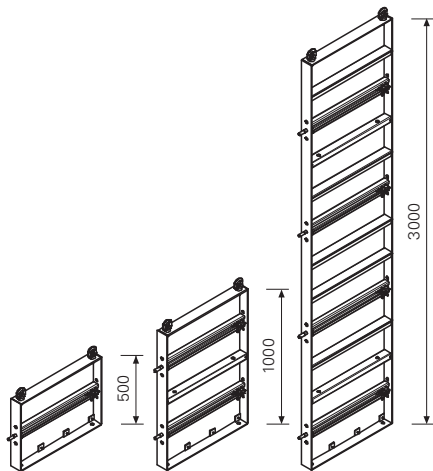

### Height increments 500 mm

Only three different element heights: 3.00 m, 1.00 m and 0.50 m. These allow optimal adjustment to the required concreting heights.



### Column cross-sections

Different cross-section combinations permit rectangular or square configurations from  $200 \times 200$  to  $600 \times 600$  mm in 50 mm increments.

3.00 m high LICO column formwork with RSS I Push-Pull Props for construction of an office building.



Captive column tie bolts and nuts are permanently attached to each element.



Eye bolt as load bearing point for moving as well as easy and simple extensions.

LICO chamfer strip, Item no. 111975, is simply attached to the front side of the element.

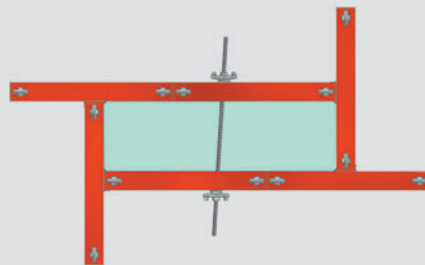
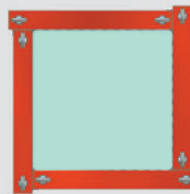
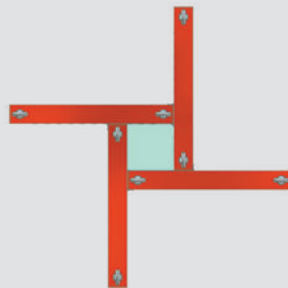

Column cross-sections from 200 x 200 mm to 600 x 600 mm can be realised both square or rectangular-shaped in 50 mm increments.

With centrally-positioned ties, cross-sections up to 60 x 130 mm can be formed. Element connections are carried out using standard M20 bolts.

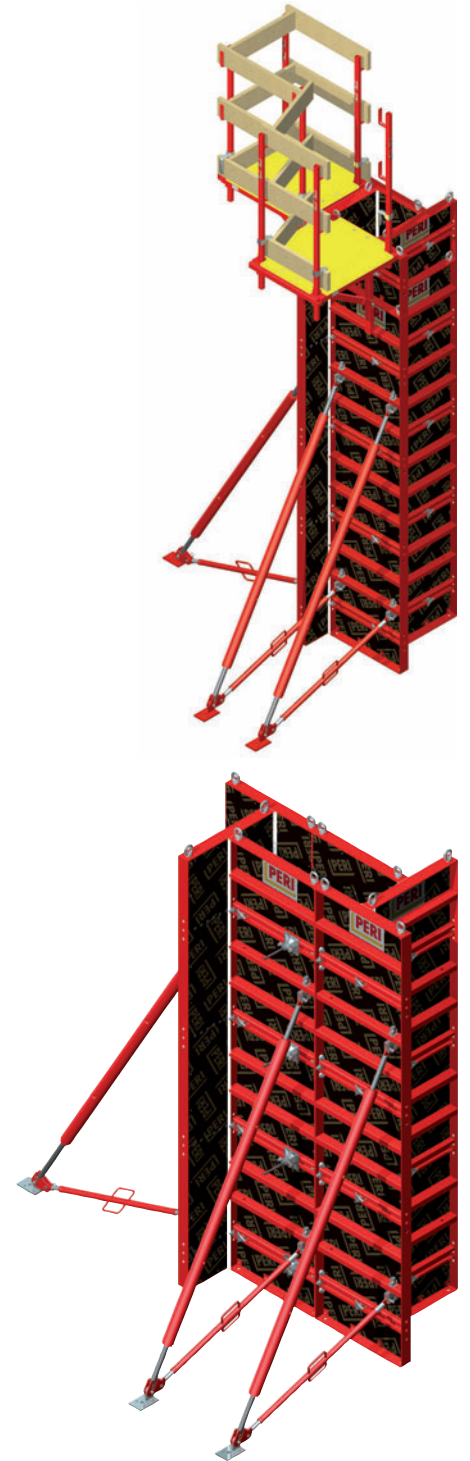

**Practice-oriented details**

- The LICO captive column tie bolts and nuts are permanently attached to the elements.
- Eye bolts on all elements serve as load bearing points for moving with the crane as well as for element connections when extending.
- The chamfer strips are easily fitted on the elements – this saves on time-consuming and cost-intensive nailing of conventional strips.



Item no.	Weight kg
111683	74.700

### Column Panel LICO 700 x 3000

Column panels for cross-sections from 20 x 20 cm up to 60 x 60 cm in 5 cm increments. 12 mm Fin-Ply formlining.

### Complete with

- 4 pc. 111679 Column Tie Nut LICO DW 15
- 4 pc. 111682 Column Tie Bolt LICO DW 15
- 2 pc. 710130 Loop Bolt M20 x 40, galv.
- 2 pc. 781053 Nut ISO 7042 M20-8, galv.
- 48 pc. 030290 Plug Ø 20 mm

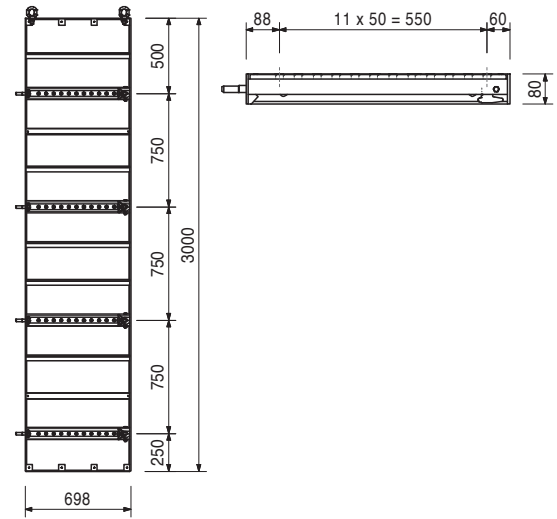

111957	32.600
--------	--------

### Column Panel LICO 700 x 1000

Column panels for cross-sections from 20 x 20 cm up to 60 x 60 cm in 5 cm increments. 12 mm Fin-Ply formlining.

### Complete with

- 2 pc. 111679 Column Tie Nut LICO DW 15
- 2 pc. 111682 Column Tie Bolt LICO DW 15
- 2 pc. 710130 Loop Bolt M20 x 40, galv.
- 2 pc. 781053 Nut ISO 7042 M20-8, galv.
- 24 pc. 030290 Plug Ø 20 mm

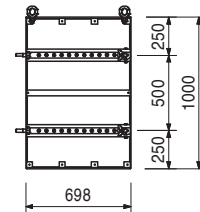
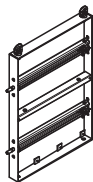

111964	17.000
--------	--------

### Column Panel LICO 700 x 500

Column panels for cross-sections from 20 x 20 cm up to 60 x 60 cm in 5 cm increments. 12 mm Fin-Ply formlining.

### Complete with

- 1 pc. 111679 Column Tie Nut LICO DW 15
- 1 pc. 111682 Column Tie Bolt LICO DW 15
- 2 pc. 710130 Loop Bolt M20 x 40, galv.
- 2 pc. 781053 Nut ISO 7042 M20-8, galv.
- 12 pc. 030290 Plug Ø 20 mm

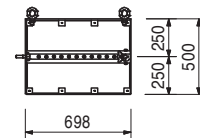
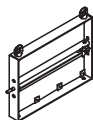

# LICO Column Formwork

Item no.	Weight kg
111975	1.080

**Chamfer Strip LICO I = 3.00 m**  
For attaching to the LICO column panels.

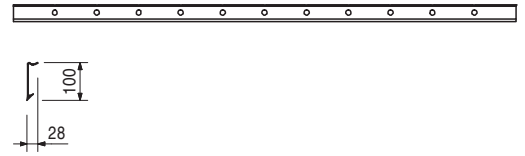
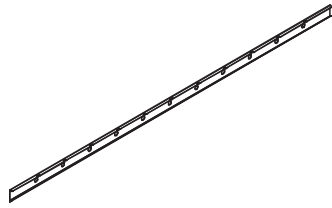

037530	1.130
--------	-------

**Brace Connector QUATTRO QR**  
For connecting push-pull props and kicker braces to QUATTRO and LICO panels.

**Complete with**  
1 pc. 027170 Pin  $\varnothing$  16 x 42, galv.  
1 pc. 018060 Cotter Pin 4/1, galv.

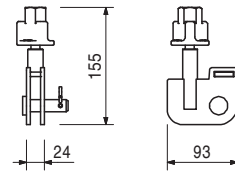

115019	0.334
--------	-------

**Lifting Pin LICO**

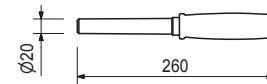
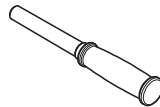

030290	0.002
--------	-------

**Plug  $\varnothing$  20 mm**  
For closing  $\varnothing$  20 mm tie holes which are not required.

**Note**  
Delivery unit 500 pieces.

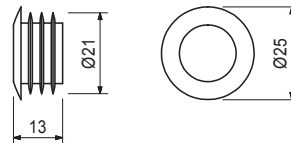

124739	0.003
--------	-------

**Plug  $\varnothing$  20 mm LICO**  
For closing  $\varnothing$  20 mm tie holes which are not required.

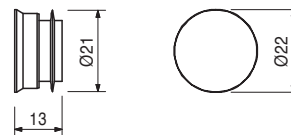

# LICO Column Formwork



Item no.	Weight kg
116432	0.957

**Spanner LICO**  
For tying LICO column formwork.

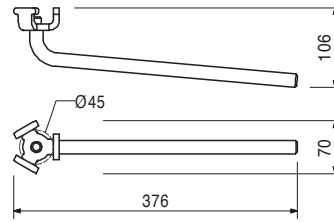
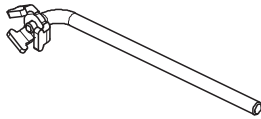

115894	22.900
--------	--------

**Concreting Platform LICO**  
Working and concreting platform for LICO column formwork.

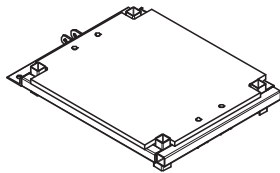

**Technical Data**  
Permissible load 150 kg/m<sup>2</sup>.

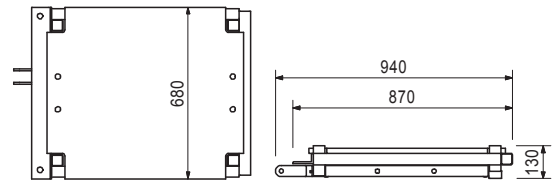

116292	4.730
--------	-------

Accessories  
**Guardrail Post HSGP-2**

115895	17.600
--------	--------

**Concreting Platform LICO Frame**  
Working and concreting platform for LICO column formwork. Decking by customer.

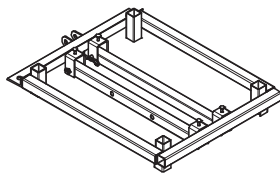

**Technical Data**  
Permissible load 150 kg/m<sup>2</sup>.

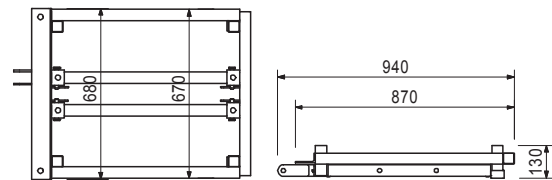

115896	5.270
--------	-------

**Concreting Platform LICO Cover**  
As replacement cover for Concreting Platform LICO.

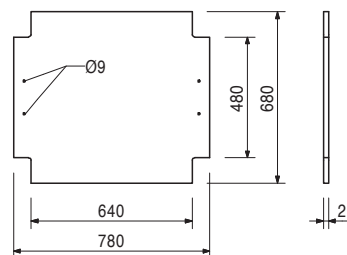
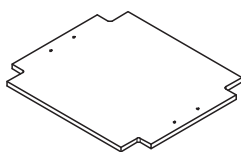

Item no.	Weight kg
116292	4.730

**Guardrail Post HSGP-2**  
As guardrail for different systems.

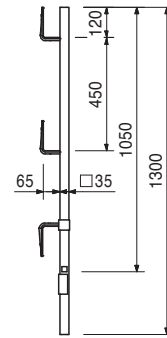

114620	0.026
--------	-------

**Stacking Aid LICO**  
For easy stacking of LICO panels.

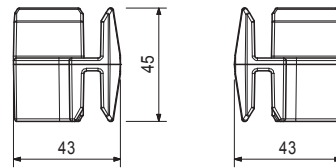
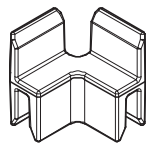

034630	0.008
--------	-------

**Stacking Device-2 LICO**

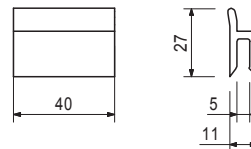
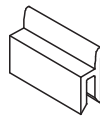

117466	10.600
--------	--------

**Push-Pull Prop RS 210, galv.**  
Extension length  $l = 1.30 - 2.10$  m.  
For aligning PERI formwork systems and precast concrete elements.

**Note**  
Permissible load see PERI Design Tables.

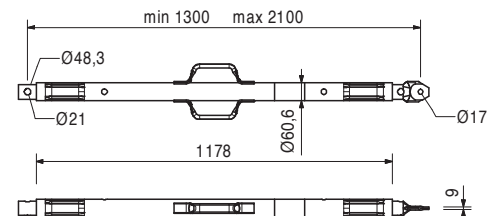
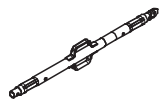

Item no.	Weight kg
118238	12.200

**Push-Pull Prop RS 260, galv.**

Extension length  $l = 2.30 - 2.60$  m.  
For aligning PERI formwork systems and precast concrete elements.

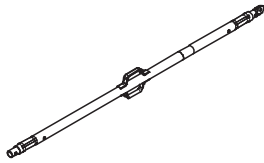

**Note**

Permissible load see PERI Design Tables.

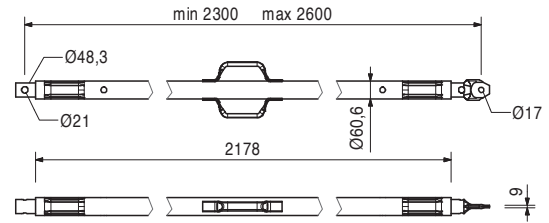

117467	15.500
--------	--------

**Push-Pull Prop RS 300, galv.**

Extension length  $l = 1.90 - 3.00$  m.  
For aligning PERI formwork systems and precast concrete elements.

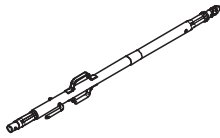

**Note**

Permissible load see PERI Design Tables.

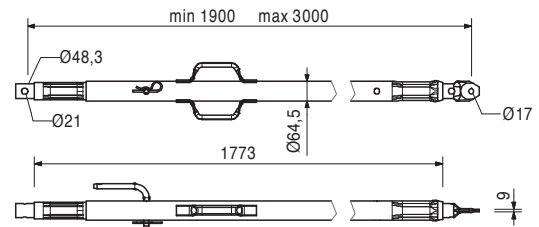

117468	23.000
--------	--------

**Push-Pull Prop RS 450, galv.**

Extension length  $l = 2.80 - 4.50$  m.  
For aligning PERI formwork systems and precast concrete elements.

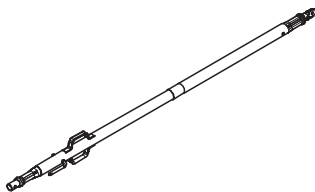

**Note**

Permissible load see PERI Design Tables.

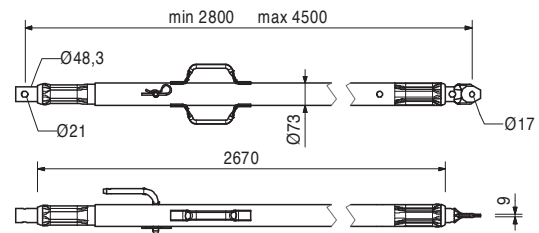

117469	40.000
--------	--------

**Push-Pull Prop RS 650, galv.**

Extension length  $l = 4.30 - 6.50$  m.  
For aligning PERI formwork systems and precast concrete elements.

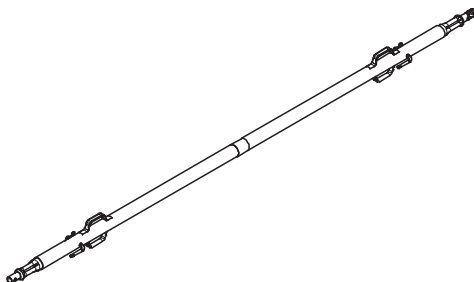

**Note**

Permissible load see PERI Design Tables.

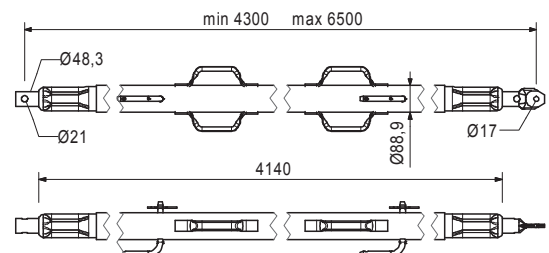



# LICO Column Formwork



Item no.	Weight kg
028990	115.000

**Push-Pull Prop RS 1000, galv.**  
 Extension length  $l = 6.40 - 10.00$  m.  
 For aligning PERI formwork systems.

**Note**  
 Permissible load see PERI Design Tables.

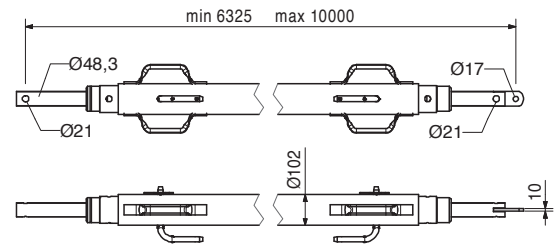
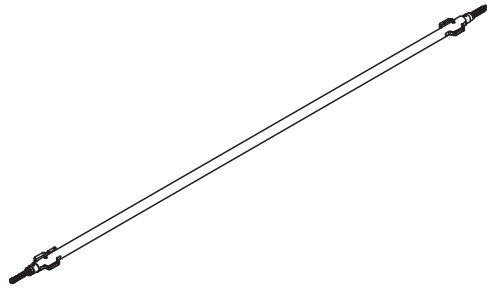

103800	271.000
--------	---------

**Push-Pull Prop RS 1400, galv.**  
 Extension length  $l = 6.40 - 14.00$  m.  
 For aligning PERI formwork systems.

**Note**  
 Permissible load see PERI Design Tables.  
 Chain can be operated from bottom.

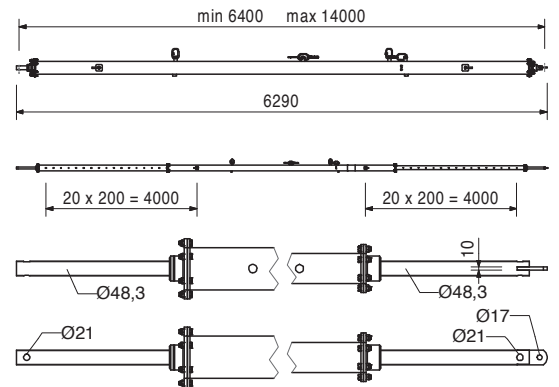
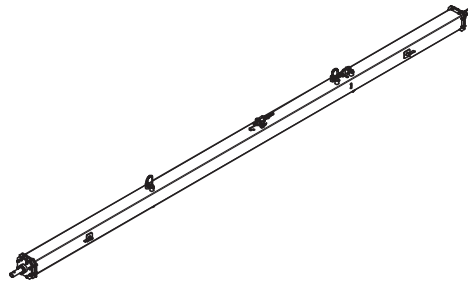

117343	3.250
--------	-------

**Base Plate-2 for RS 210 – 1400, galv.**  
 For assembly of Push-Pull Props RS 210, 260, 300, 450, 650, 1000 and 1400.

**Complete with**  
 2 pc. 105400 Pin Ø 20 x 140, galv.  
 2 pc. 018060 Cotter Pin 4/1, galv.

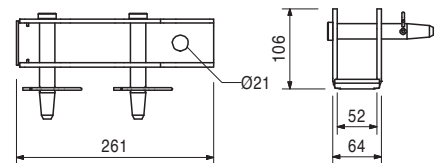
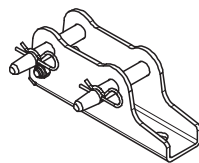

124777	0.210
--------	-------

Accessories  
**Anchor Bolt PERI 14/20 x 130**

Item no.	Weight kg
126666	3.070

### Base Plate-3 for RS 210-1400

For assembly of Push-Pull Props RS 210, 260, 300, 450, 650, 1000 and 1400.

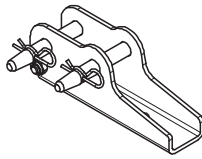

### Complete with

- 2 pc. 105400 Pin  $\varnothing$  20 x 140, galv.
- 2 pc. 018060 Cotter Pin 4/1, galv.
- 1 pc. 113063 Bolt ISO 4014 M12 x 80-8.8, galv.

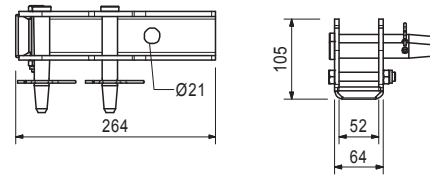

028010	17.900
--------	--------

### Push-Pull Prop RSS I

Extension length  $l = 2.05 - 2.94$  m.  
For aligning PERI formwork systems.

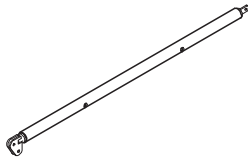

### Note

Permissible load see PERI Design Tables.

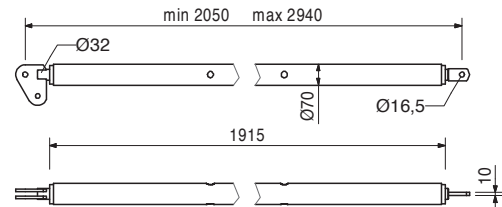

113397	1.600
--------	-------

### Spindle Handle RSS / AV

Spindle Handle for screwing on Push-Pull-Props RSS I, RSS II, RSS III and Kickers AV 210 and AV 190 complete with 2 bolts and nuts M8.

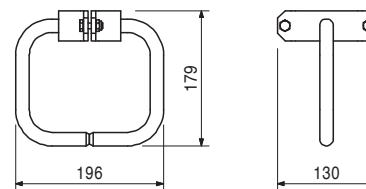
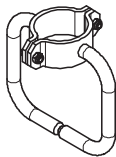

028020	22.000
--------	--------

### Push-Pull Prop RSS II

Extension length  $l = 2.91 - 3.80$  m.  
For aligning PERI formwork systems.

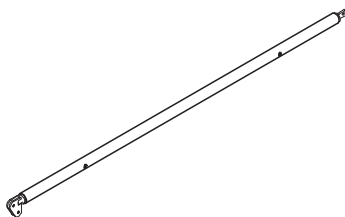

### Note

Permissible load see PERI Design Tables.

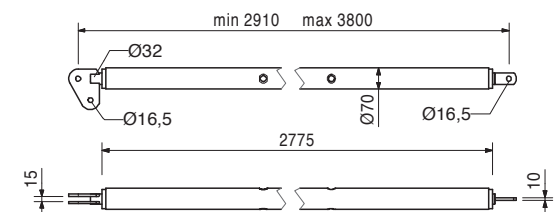

Item no.	Weight kg
028030	38.400

**Push-Pull Prop RSS III**  
 Extension length l = 4.60 – 6.00 m.  
 For aligning PERI formwork systems.

**Note**  
 Permissible load see PERI Design Tables.

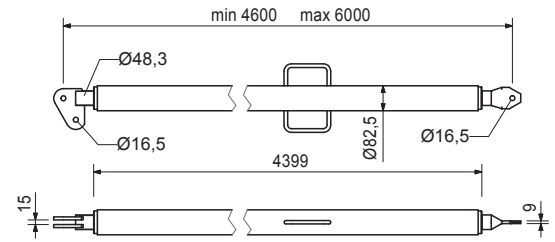
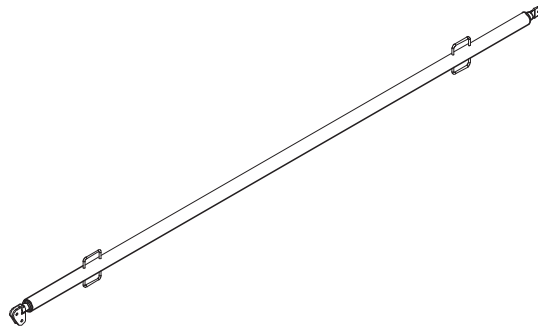

106000	1.820
--------	-------

**Base Plate-2 for RSS, galv.**  
 For assembly of RSS Push-Pull Props.

**Complete with**  
 1 pc. 027170 Pin Ø 16 x 42, galv.  
 1 pc. 018060 Cotter Pin 4/1, galv.

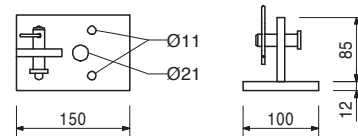
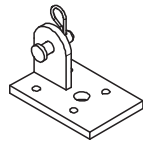

Accessories  
**Anchor Bolt PERI 14/20 x 130**

124777	0.210
--------	-------

057087	3.720
057088	4.410

**Kickers AV**  
**Kicker AV 82**  
**Kicker AV 111**  
 For aligning PERI formwork systems.

min. L	max. L
500	820
790	1110

**Complete with**  
 1 pc. 027170 Pin Ø 16 x 42, galv.  
 1 pc. 018060 Cotter Pin 4/1, galv.

**Note**  
 Permissible load see PERI Design Tables.

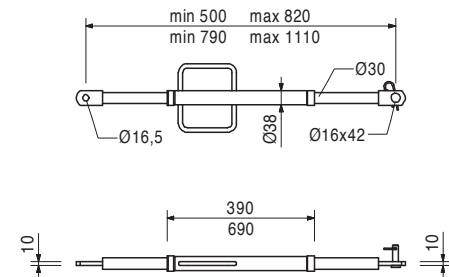
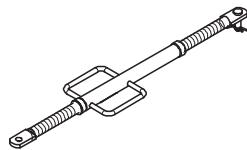

Item no.	Weight kg
028110	5.180

**Kicker AV 140**  
 Extension length  $l = 1.08 - 1.40$  m.  
 For aligning PERI formwork systems.

**Complete with**  
 1 pc. 027170 Pin  $\varnothing 16 \times 42$ , galv.  
 1 pc. 018060 Cotter Pin 4/1, galv.

**Note**  
 Permissible load see PERI Design Tables.

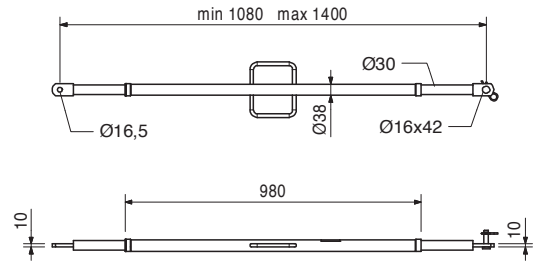
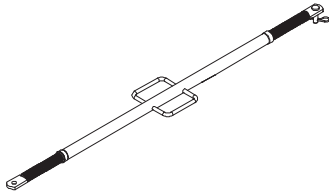

108135	12.900
--------	--------

**Kicker AV 210**  
 Extension length  $l = 1.28 - 2.10$  m.  
 For aligning PERI formwork systems.

**Complete with**  
 1 pc. 027170 Pin  $\varnothing 16 \times 42$ , galv.  
 1 pc. 018060 Cotter Pin 4/1, galv.

**Note**  
 Permissible load see PERI Design Tables.

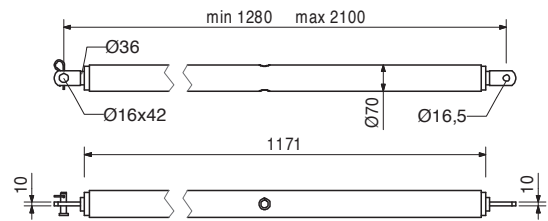
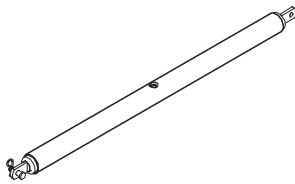

028120	17.000
--------	--------

**Kicker AV RSS III**  
 Extension length  $l = 2.03 - 2.92$  m.  
 For aligning PERI formwork systems.

**Complete with**  
 1 pc. 027170 Pin  $\varnothing 16 \times 42$ , galv.  
 1 pc. 018060 Cotter Pin 4/1, galv.

**Note**  
 Permissible load see PERI Design Tables.

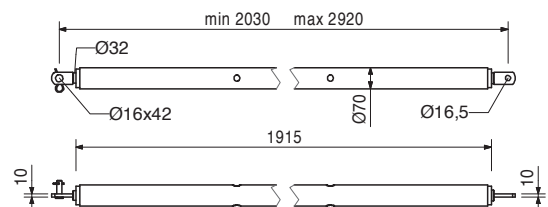
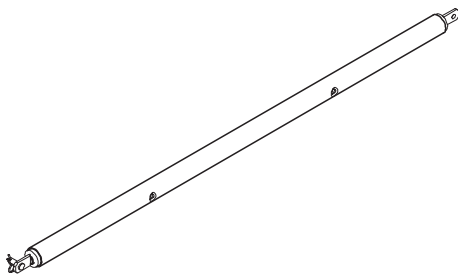

Item no.	Weight kg
124777	0.210

## Anchor Bolt PERI 14/20 x 130

For temporary fixation to reinforced concrete structures.

## Note

See PERI data sheet!  
Drilling  $\varnothing$  14 mm.

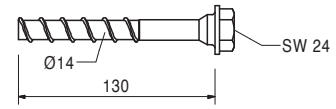
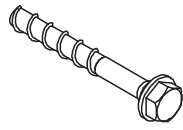

# PERI International



**01 Germany**  
**PERI GmbH**  
 Rudolf-Diesel-Strasse 19  
 89264 Weissenhorn  
 info@peri.com  
 www.peri.com



**02 France**  
 PERI S.A.S.  
 77109 Meaux Cedex  
 peri.sas@peri.fr  
 www.peri.fr

**03 Switzerland**  
 PERI AG  
 8472 Ohringen  
 info@peri.ch  
 www.peri.ch

**04 Spain**  
 PERI S.A.U.  
 28110 Algete - Madrid  
 info@peri.es  
 www.peri.es

**05 Belgium/Luxembourg**  
 N.V. PERI S.A.  
 1840 Londerzeel  
 info@peri.be  
 www.peri.be

**06 Netherlands**  
 PERI Holding B.V.  
 5480 AH-Schijndel  
 info@peri.nl  
 www.peri.nl

**07 USA**  
 PERI Formwork Systems, Inc.  
 Elkridge, MD 21075  
 info@peri-usa.com  
 www.peri-usa.com

**08 Indonesia**  
 PT Beton Perkasa Wijaksana  
 Jakarta 10210  
 bpw@betonperkasa.com  
 www.peri.com

**09 Italy**  
 PERI S.p.A.  
 20060 Basiano  
 info@peri.it  
 www.peri.it

**10 Japan**  
 PERI Japan K.K.  
 Tokyo 103-0015  
 info@perijapan.jp  
 www.perijapan.jp

**11 United Kingdom/Ireland**  
 PERI Ltd.  
 Rugby, CV23 0AN  
 info@peri.ltd.uk  
 www.peri.ltd.uk

**12 Turkey**  
 PERI Kalip ve Iskeleleri Sanayi  
 ve Ticaret Ltd.  
 Esenyurt / İstanbul 34510  
 info@peri.com.tr  
 www.peri.com.tr

**13 Hungary**  
 PERI Kft.  
 1181 Budapest  
 info@peri.hu  
 www.peri.hu

**14 Malaysia**  
 PERI Formwork Malaysia Sdn. Bhd.  
 43300 Seri Kembangan,  
 Selangor Darul Ehsan  
 info@perimalaysia.com  
 www.perimalaysia.com

**15 Singapore**  
 PERI Asia Pte Ltd  
 Singapore 387355  
 pha@periasia.com  
 www.periasia.com

**16 Austria**  
 PERI Ges.mbh  
 3134 Nußdorf ob der Traisen  
 office@peri.at  
 www.peri.at

**17 Czech Republic**  
 PERI spol. S r.o.  
 252 42 Jesenice u Prahy  
 info@peri.cz  
 www.peri.cz

**18 Denmark**  
 PERI Danmark A/S  
 2670 Greve  
 peri@peri.dk  
 www.peri.dk

**19 Finland**  
 PERI Formas Ltd. Oy  
 05460 Hyvinkää  
 info@perisuomi.fi  
 www.perisuomi.fi

**20 Norway**  
 PERI Norge AS  
 3036 Drammen  
 info@peri.no  
 www.peri.no

**21 Poland**  
 PERI Polska Sp. z o.o.  
 05-860 Płochocin  
 info@peri.com.pl  
 www.peri.com.pl

**22 Sweden**  
 PERIform Sverige AB  
 30262 Halmstad  
 peri@periform.se  
 www.periform.se

**23 Korea**  
 PERI (Korea) Ltd.  
 Seoul 06243  
 info@perikorea.com  
 www.perikorea.com

**24 Portugal**  
 Pericofragens Lda.  
 2790-326 Queijas  
 info@peri.pt  
 www.peri.pt

**25 Argentina**  
 PERI S.A.  
 B1625GPA Escobar – Bs. As.  
 info@peri.com.ar  
 www.peri.com.ar

**26 Brazil**  
 PERI Formas e  
 Escoramentos Ltda.  
 Vargem Grande Paulista – SP  
 info@peribrasil.com.br  
 www.peribrasil.com.br

**27 Chile**  
 PERI Chile Ltda.  
 Colina, Santiago de Chile  
 perichile@peri.cl  
 www.peri.cl

**28 Romania**  
 PERI România SRL  
 077015 Balotești  
 info@peri.ro  
 www.peri.ro

**29 Slovenia**  
 PERI Agency  
 2000 Maribor  
 peri.slo@triera.net  
 www.peri.com

**30 Slovakia**  
 PERI spol. s. r.o.  
 903 01 Senec  
 info@peri.sk  
 www.peri.sk

**31 Australia**  
 PERI Australia Pty. Ltd.  
 Glendenning NSW 2761  
 info@periaus.com.au  
 www.periaus.com.au

**32 Estonia**  
 PERI AS  
 76406 Saku vald  
 Harjumaa  
 peri@peri.ee  
 www.peri.ee

**33 Greece**  
 PERI Hellas Solely Owned Ltd.  
 194 00 Koropi  
 info@perihellas.gr  
 www.perihellas.gr

**34 Latvia**  
 PERI SIA  
 2118 Salaspils novads, Rigas rajons  
 info@peri-latvija.lv  
 www.peri-latvija.lv

**35 United Arab Emirates**  
 PERI (L.L.C.)  
 Dubai U.A.E.  
 perillc@perime.com  
 www.perime.com

**36 Canada**  
 PERI Formwork Systems, Inc.  
 Bolton, ON – L7E 1K1  
 info@peri.ca  
 www.peri.ca





- |   |   |   |  |  |
|---|---|---|--|--|
| <p><b>37 Lebanon</b><br/>PERI Lebanon Sarl<br/>90416 – Jdeideh<br/>lebanon@peri.de</p>  | <p><b>44 Russian Federation</b><br/>OOO PERI<br/>142407, Noginsk District<br/>moscow@peri.ru<br/>www.peri.ru</p>                                | <p><b>51 Turkmenistan</b><br/>PERI Kalıp ve İskeleleri<br/>Aşgabat<br/>ahmet.kadioglu@peri.com.tr<br/>www.peri.com.tr</p> | <p><b>57 Saudi Arabia</b><br/>PERI Saudi Arabia Ltd.<br/>21463 Jeddah<br/>info@peri.com.sa<br/>www.peri.com.sa</p>     | <p><b>64 Nigeria</b><br/>PERI Nigeria Ltd.<br/>Lagos<br/>info@peri.ng<br/>www.peri.ng</p>                                      |
| <p><b>38 Lithuania</b><br/>PERI UAB<br/>02300 Vilnius<br/>info@peri.lt<br/>www.peri.lt</p>                                    | <p><b>45 South Africa</b><br/>PERI (Pty) Ltd<br/>7600 Stellenbosch<br/>info@peri.co.za<br/>www.peri.co.za</p>                                   | <p><b>52 Belorussia</b><br/>IOOO PERI Belarus<br/>220100 Minsk<br/>info@peri.by<br/>www.peri.by</p>                       | <p><b>58 Qatar</b><br/>PERI Qatar LLC<br/>P.O.Box: 31295 - Doha<br/>info@periqatar.com<br/>www.peri.qa</p>             | <p><b>65 Oman</b><br/>PERI (L.L.C.)<br/>Muscat<br/>perimct@perime.com<br/>www.perime.com</p>                                   |
| <p><b>39 Morocco</b><br/>PERI S.A.U.<br/>Tanger<br/>info@peri.ma<br/>www.peri.ma</p>  | <p><b>46 Ukraine</b><br/>TOW PERI<br/>07400 Brovary<br/>peri@peri.ua<br/>www.peri.ua</p>  | <p><b>53 Croatia</b><br/>PERI oplate i skele d.o.o.<br/>10 250 Lučko-Zagreb<br/>info@peri.com.hr<br/>www.peri.com.hr</p>  | <p><b>59 Algeria</b><br/>Sarl PERI<br/>Kouba 16092, Alger<br/>info@peri.com<br/>www.peri.com</p>                       | <p><b>66 Colombia</b><br/>PERI S.A.S. Colombia<br/>Briceño, Cundinamarca<br/>peri.colombia@peri.com.co<br/>www.peri.com.co</p> |
| <p><b>40 Israel</b><br/>PERI Formwork<br/>Engineering Ltd.<br/>Rosh Ha'ayin, 48104<br/>info@peri.co.il<br/>www.peri.co.il</p> | <p><b>47 Egypt</b><br/>PERI Branch Office<br/>11341 Nasr City /Cairo<br/>info@peri.com.eg<br/>www.peri.com.eg</p>                               | <p><b>54 India</b><br/>PERI (India) Pvt Ltd<br/>Mumbai – 400064<br/>info@peri.in<br/>www.peri.in</p>                      | <p><b>60 Albania</b><br/>PERI Representative Office<br/>Tirane<br/>info@peri.com.tr<br/>www.peri.com.tr</p>            | <p><b>67 Philippines</b><br/>PERI-Asia Philippines, INC.<br/>Makati City<br/>info@peri.com.ph<br/>www.peri.com.ph</p>          |
| <p><b>41 Bulgaria</b><br/>PERI Bulgaria EOOD<br/>1839 Sofia<br/>peri.bulgaria@peri.bg<br/>www.peri.bg</p>                     | <p><b>48 Serbia</b><br/>PERI – Oplate d.o.o.<br/>22310 Šimanovci<br/>office@peri.rs<br/>www.peri.rs</p>   | <p><b>55 Jordan</b><br/>PERI GmbH - Jordan<br/>11947 Amman<br/>jordan@peri.com<br/>www.peri.com</p>                       | <p><b>61 Peru</b><br/>PERI Peruana S.A.C.<br/>Villa El Salvador, Lima<br/>contacto@peri.com.pe<br/>www.peri.com.pe</p> | <p><b>68 Hong Kong</b><br/>PERI (Hong Kong) Limited<br/>Hong Kong SAR, PRC<br/>bob.dover@periasia.com<br/>www.perihk.com</p>   |
| <p><b>42 Iceland</b><br/>Armar ehf.<br/>220 Hafnarfjörður<br/>armar@armar.is<br/>www.armar.is</p>                             | <p><b>49 Mexico</b><br/>PERI Cimbras y Andamios,<br/>S.A. de C.V.<br/>Estado de México, Huehuetoca<br/>info@peri.com.mx<br/>www.peri.com.mx</p> | <p><b>56 Kuwait</b><br/>PERI Kuwait W.L.L.<br/>13011 Kuwait<br/>info@peri.com.kw<br/>www.peri.com.kw</p>                  | <p><b>62 Panama</b><br/>PERI Panama Inc.<br/>0832-00155 Panama City<br/>info@peri.com.pa<br/>www.peri.com.pa</p>       | <p><b>69 Namibia</b><br/>PERI (Pty.) Ltd.<br/>Windhoek<br/>windhoek@peri.na<br/>www.peri.na</p>                                |
| <p><b>43 Kazakhstan</b><br/>TOO PERI Kazakhstan<br/>050000 Almaty<br/>peri@peri.kz<br/>www.peri.kz</p>                        | <p><b>50 Azerbaijan</b><br/>PERI Representative Office<br/>Baku<br/>peribaku@peri.com.tr<br/>www.peri.com.tr</p>                                | <p><b>63 Angola</b><br/>Pericofragens, Lda.<br/>Luanda<br/>renato.portugal@peri.pt<br/>www.peri.pt</p>                    | <p><b>70 Mozambique</b><br/>PERI (Pty.) Ltd.<br/>Matola<br/>maputo@peri.co.mz<br/>www.peri.co.mz</p>                   |  |

# The optimal System for every Project and every Requirement



Wall Formwork



Column Formwork



Slab Formwork



Climbing Systems



Tunnel Formwork



Bridge Formwork



Shoring Systems



Construction Scaffold



Facade Scaffold



Industrial Scaffold



Access



Protection Scaffold



System-Independent Accessories



Services



**PERI GmbH**  
**Formwork Scaffolding Engineering**  
 Rudolf-Diesel-Strasse 19  
 89264 Weissenhorn  
 Germany  
 Tel. +49 (0)7309.950-0  
 Fax +49 (0)7309.951-0  
 info@peri.com  
 www.peri.com